

DS90CF383 +3.3V LVDS Transmitter 24-Bit Flat Panel Display (FPD) Link—65 MHz

General Description

The DS90CF383 transmitter converts 28 bits of CMOS/TTL data into four LVDS (Low Voltage Differential Signaling) data streams. A phase-locked transmit clock is transmitted in parallel with the data streams over a fifth LVDS link. Every cycle of the transmit clock 28 bits of input data are sampled and transmitted. At a transmit clock frequency of 65 MHz, 24 bits of RGB data and 3 bits of LCD timing and control data (FPLINE, FPFRAME, DRDY) are transmitted at a rate of 455 Mbps per LVDS data channel. Using a 65 MHz clock, the data throughput is 227 Mbytes/sec.

This chipset is an ideal means to solve EMI and cable size problems associated with wide, high speed TTL interfaces.

Features

- 20 to 65 MHz shift clock support
- Single 3.3V supply
- Chipset (Tx + Rx) power consumption < 250 mW (typ)
- Power-down mode (< 0.5 mW total)
- Single pixel per clock XGA (1024x768) ready
- Supports VGA, SVGA, XGA and higher addressability.
- Up to 227 Megabytes/sec bandwidth
- Up to 1.8 Gbps throughput
- Narrow bus reduces cable size and cost
- 290 mV swing LVDS devices for low EMI
- PLL requires no external components
- Low profile 56-lead TSSOP package
- Falling edge data strobe Transmitter
- Compatible with TIA/EIA-644 LVDS standard
- ESD rating > 7 kV
- Operating Temperature: -40°C to +85°C

Block Diagram

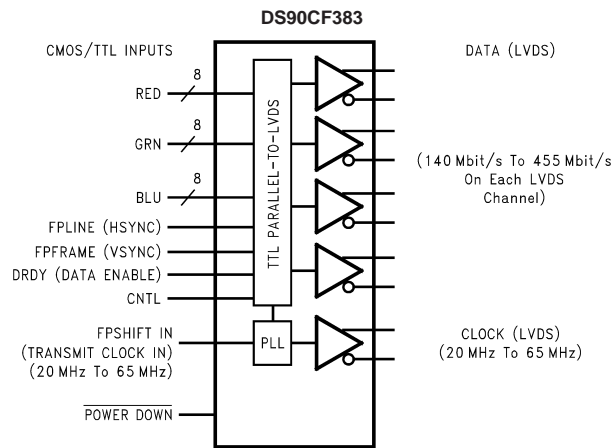

Order Number DS90CF383MTD
See NS Package Number MTD56

Absolute Maximum Ratings (Note 1)

If Military/Aerospace specified devices are required, please contact the National Semiconductor Sales Office/Distributors for availability and specifications.

Supply Voltage (V_{CC})	-0.3V to +4V
CMOS/TTL Input Voltage	-0.3V to ($V_{CC} + 0.3V$)
LVDS Driver Output Voltage	-0.3V to ($V_{CC} + 0.3V$)
LVDS Output Short Circuit Duration	Continuous
Junction Temperature	+150°C
Storage Temperature	-65°C to +150°C
Lead Temperature (Soldering, 4 sec)	+260°C
Maximum Package Power Dissipation Capacity @ 25°C	
MTD56 (TSSOP) Package: DS90CF383	1.63 W

Package Derating: DS90CF383	12.5 mW/°C above +25°C
ESD Rating (HBM, 1.5 kΩ, 100 pF)	> 7 kV

Recommended Operating Conditions

	Min	Nom	Max	Units
Supply Voltage (V_{CC})	3.0	3.3	3.6	V
Operating Free Air Temperature (T_A)	-40	+25	+85	°C
Receiver Input Range	0		2.4	V
Supply Noise Voltage (V_{CC})			100	mV _{PP}

Electrical Characteristics

Over recommended operating supply and temperature ranges unless otherwise specified.

Symbol	Parameter	Conditions	Min	Typ	Max	Units	
CMOS/TTL DC SPECIFICATIONS							
V_{IH}	High Level Input Voltage		2.0		V_{CC}	V	
V_{IL}	Low Level Input Voltage		GND		0.8	V	
V_{OH}	High Level Output Voltage	$I_{OH} = -0.4$ mA	2.7	3.3		V	
V_{OL}	Low Level Output Voltage	$I_{OL} = 2$ mA		0.1	0.3	V	
V_{CL}	Input Clamp Voltage	$I_{CL} = -18$ mA		-0.79	-1.5	V	
I_{IN}	Input Current	$V_{IN} = V_{CC}$, GND, 2.5V or 0.4V		±5.1	±10	μA	
I_{OS}	Output Short Circuit Current	$V_{OUT} = 0V$		-60	-120	mA	
LVDS DC SPECIFICATIONS							
V_{OD}	Differential Output Voltage	$R_L = 100\Omega$	250	345	450	mV	
ΔV_{OD}	Change in V_{OD} between complimentary output states				35	mV	
V_{OS}	Offset Voltage (Note 4)		1.125	1.25	1.375	V	
ΔV_{OS}	Change in V_{OS} between complimentary output states				35	mV	
I_{OS}	Output Short Circuit Current	$V_{OUT} = 0V$, $R_L = 100\Omega$		-3.5	-5	mA	
I_{OZ}	Output TRI-STATE® Current	Power Down = 0V, $V_{OUT} = 0V$ or V_{CC}		±1	±10	μA	
V_{TH}	Differential Input High Threshold	$V_{CM} = +1.2V$			+100	mV	
V_{TL}	Differential Input Low Threshold		-100			mV	
I_{IN}	Input Current	$V_{IN} = +2.4V$, $V_{CC} = 3.6V$ $V_{IN} = 0V$, $V_{CC} = 3.6V$			±10	μA	
TRANSMITTER SUPPLY CURRENT							
ICCTW	Transmitter Supply Current Worst Case	$R_L = 100\Omega$, $C_L = 5$ pF, Worst Case Pattern (Figures 1, 3)	$f = 32.5$ MHz		31	45	mA
			$f = 37.5$ MHz		32	50	mA
			$f = 65$ MHz		42	55	mA
ICCTG	Transmitter Supply Current 16 Grayscale	$R_L = 100\Omega$, $C_L = 5$ pF, 16 Grayscale Pattern (Figures 2, 3)	$f = 32.5$ MHz		23	35	mA
			$f = 37.5$ MHz		28	40	mA
			$f = 65$ MHz		31	45	mA
ICCTZ	Transmitter Supply Current Power Down	Power Down = Low Driver Outputs in TRI-STATE® under Power Down Mode		10	55	μA	

Note 1: "Absolute Maximum Ratings" are those values beyond which the safety of the device cannot be guaranteed. They are not meant to imply that the device should be operated at these limits. The tables of "Electrical Characteristics" specify conditions for device operation.

Electrical Characteristics (Continued)

Note 2: Typical values are given for $V_{CC} = 3.3V$ and $T_A = +25^{\circ}C$.

Note 3: Current into device pins is defined as positive. Current out of device pins is defined as negative. Voltages are referenced to ground unless otherwise specified (except V_{OD} and ΔV_{OD}).

Note 4: V_{OS} previously referred as V_{CM} .

Transmitter Switching Characteristics

Over recommended operating supply and temperature ranges unless otherwise specified

Symbol	Parameter	Min	Typ	Max	Units		
LLHT	LVDS Low-to-High Transition Time (Figure 3)		0.75	1.5	ns		
LHLT	LVDS High-to-Low Transition Time (Figure 3)		0.75	1.5	ns		
TCIT	TxCLK IN Transition Time (Figure 4)			5	ns		
TCCS	TxOUT Channel-to-Channel Skew (Figure 5)		250		ps		
TPPos0	Transmitter Output Pulse Position for Bit 0 (Figure 12)	f = 65 MHz		-0.4	0	0.3	ps
TPPos1	Transmitter Output Pulse Position for Bit 1			1.8	2.2	2.5	ns
TPPos2	Transmitter Output Pulse Position for Bit 2			4.0	4.4	4.7	ns
TPPos3	Transmitter Output Pulse Position for Bit 3			6.2	6.6	6.9	ns
TPPos4	Transmitter Output Pulse Position for Bit 4			8.4	8.8	9.1	ns
TPPos5	Transmitter Output Pulse Position for Bit 5			10.6	11.0	11.3	ns
TPPos6	Transmitter Output Pulse Position for Bit 6			12.8	13.2	13.5	ns
TCIP	TxCLK IN Period (Figure 6)	15	T	50	ns		
TCIH	TxCLK IN High Time (Figure 6)	0.35T	0.5T	0.65T	ns		
TCIL	TxCLK IN Low Time (Figure 6)	0.35T	0.5T	0.65T	ns		
TSTC	TxIN Setup to TxCLK IN (Figure 6)	f = 65 MHz		2.5		ns	
THTC	TxIN Hold to TxCLK IN (Figure 6)	f = 65 MHz		0		ns	
TCCD	TxCLK IN to TxCLK OUT Delay 25°C, $V_{CC} = 3.3V$ (Figure 7)	3		5.5	ns		
TPLLS	Transmitter Phase Lock Loop Set (Figure 8)			10	ms		
TPDD	Transmitter Power Down Delay (Figure 11)			100	ns		

AC Timing Diagrams

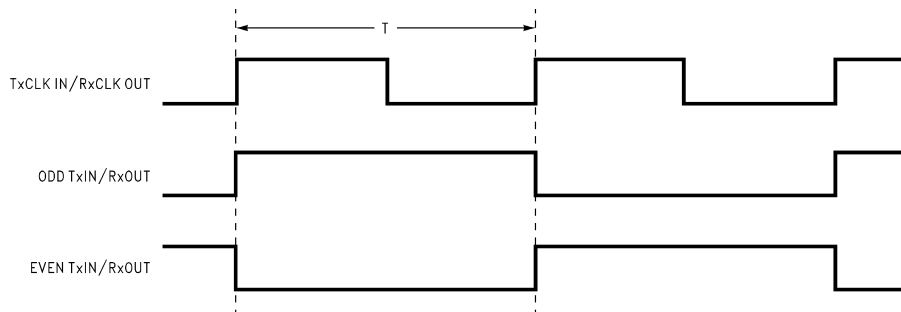

DS100033-4

FIGURE 1. "Worst Case" Test Pattern

AC Timing Diagrams (Continued)

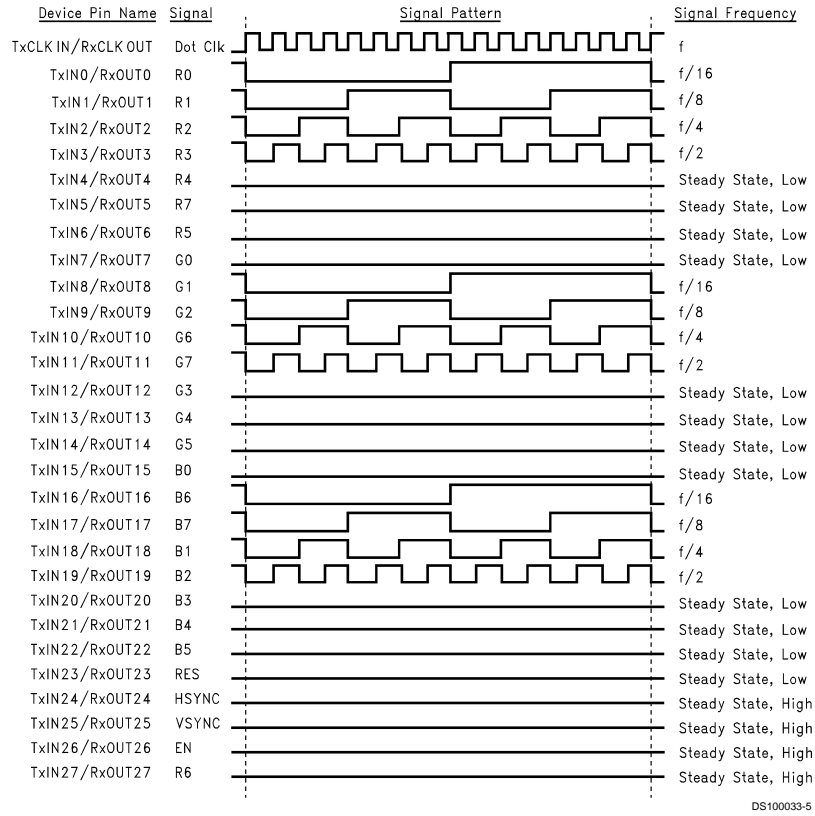

FIGURE 2. "16 Grayscale" Test Pattern (Notes 5, 6, 7, 8)

Note 5: The worst case test pattern produces a maximum toggling of digital circuits, LVDS I/O and CMOS/TTL I/O.

Note 6: The 16 grayscale test pattern tests device power consumption for a "typical" LCD display pattern. The test pattern approximates signal switching needed to produce groups of 16 vertical stripes across the display.

Note 7: Figures 1, 2 show a falling edge data strobe (TxCLK IN/RxCLK OUT).

Note 8: Recommended pin to signal mapping. Customer may choose to define differently.

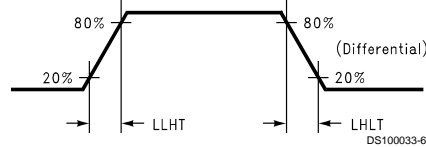

FIGURE 3. DS90CF383 (Transmitter) LVDS Output Load and Transition Times

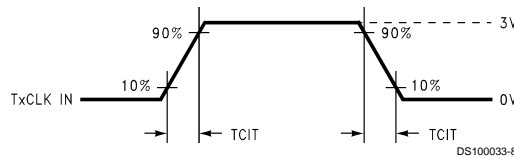
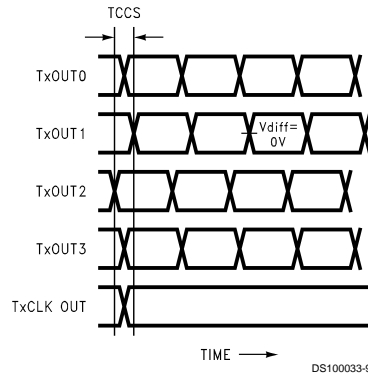

FIGURE 4. DS90CF383 (Transmitter) Input Clock Transition Time

AC Timing Diagrams (Continued)



Measurements at $V_{diff} = 0V$
 TCCS measured between earliest and latest LVDS edges
 TxCLK Differential Low \rightarrow High Edge

FIGURE 5. DS90CF383 (Transmitter) Channel-to-Channel Skew

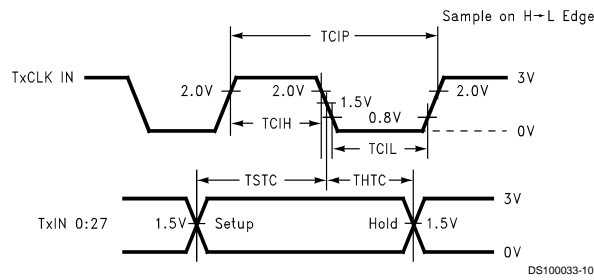

FIGURE 6. DS90CF383 (Transmitter) Setup/Hold and High/Low Times (Falling Edge Strobe)

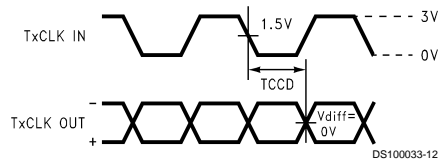

FIGURE 7. DS90CF383 (Transmitter) Clock In to Clock Out Delay

AC Timing Diagrams (Continued)

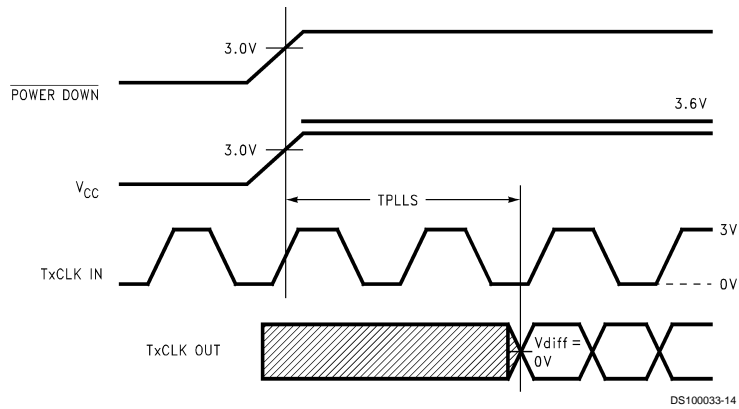

FIGURE 8. DS90CF383 (Transmitter) Phase Lock Loop Set Time

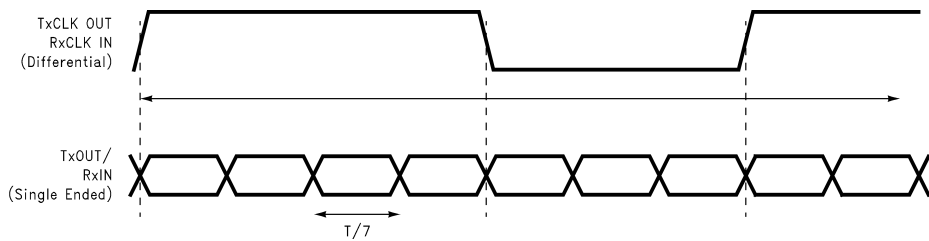

FIGURE 9. Seven Bits of LVDS in Once Clock Cycle

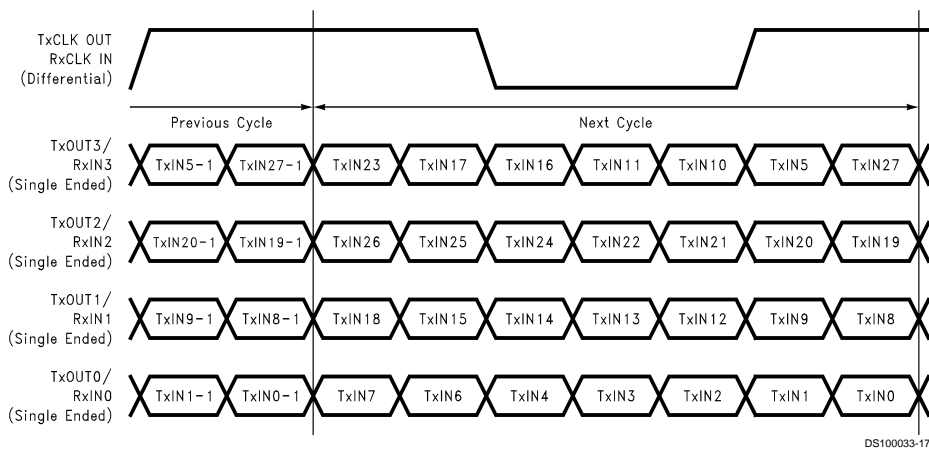

FIGURE 10. 21 Parallel TTL Data Inputs Mapped to LVDS Outputs

AC Timing Diagrams (Continued)

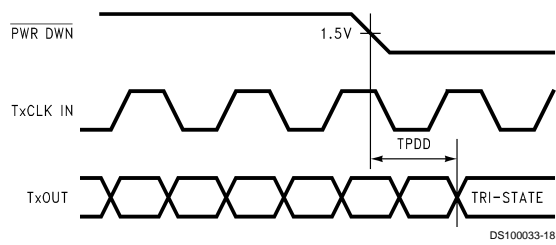

FIGURE 11. Transmitter Power Down Delay

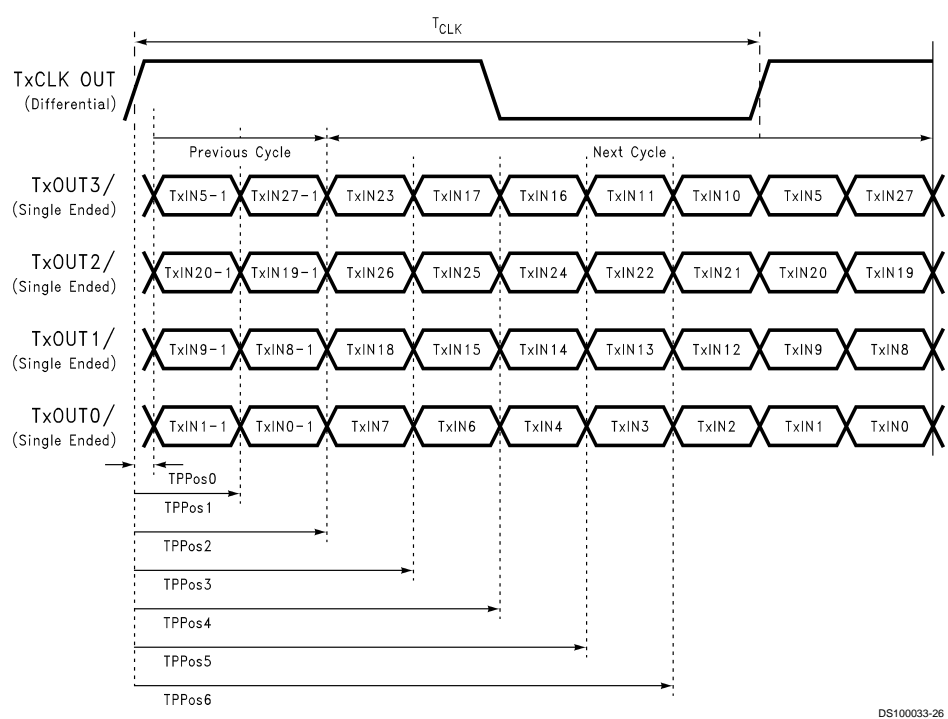

FIGURE 12. Transmitter LVDS Output Pulse Position Measurement

DS90CF383 Pin Description—FPD Link Transmitter

Pin Name	I/O	No.	Description
TxIN	I	28	TTL level input. This includes: 8 Red, 8 Green, 8 Blue, and 4 control lines— FPLINE, FPFrames and DRDY (also referred to as HSYNC, VSYNC, Data Enable).
TxOUT+	O	4	Positive LVDS differential data output.
TxOUT-	O	4	Negative LVDS differential data output.
FPSHIFT IN	I	1	TTL level clock input. The falling edge acts as data strobe. Pin name TxCLK IN.
TxCLK OUT+	O	1	Positive LVDS differential clock output.
TxCLK OUT-	O	1	Negative LVDS differential clock output.
PWR DOWN	I	1	TTL level input. When asserted (low input) TRI-STATES the outputs, ensuring low current at power down.
V _{CC}	I	4	Power supply pins for TTL inputs.

DS90CF383 Pin Description—FPD Link Transmitter (Continued)

Pin Name	I/O	No.	Description
GND	I	4	Ground pins for TTL inputs.
PLL V _{CC}	I	1	Power supply pin for PLL.
PLL GND	I	2	Ground pins for PLL.
LVDS V _{CC}	I	1	Power supply pin for LVDS outputs.
LVDS GND	I	3	Ground pins for LVDS outputs.

Applications Information

The DS90CF383 and DS90CF384 are backward compatible with the existing 5V FPD Link transmitter/receiver pair (DS90CF583 and DS90CF584). To upgrade from a 5V to a 3.3V system the following must be addressed:

1. Change 5V power supply to 3.3V. Provide this supply to the V_{CC}, LVDS V_{CC} and PLL V_{CC} of both the transmitter

and receiver devices. This change may enable the removal of a 5V supply from the system, and power may be supplied from an existing 3V power source.

2. The DS90CF383 transmitter input and control inputs accept 3.3V TTL/CMOS levels. They are not 5V tolerant.

Pin Diagram

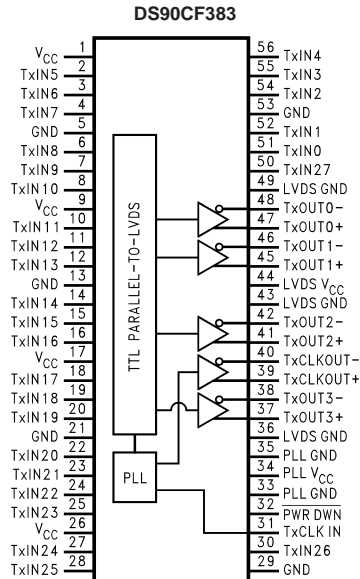

DS100033-23

Application

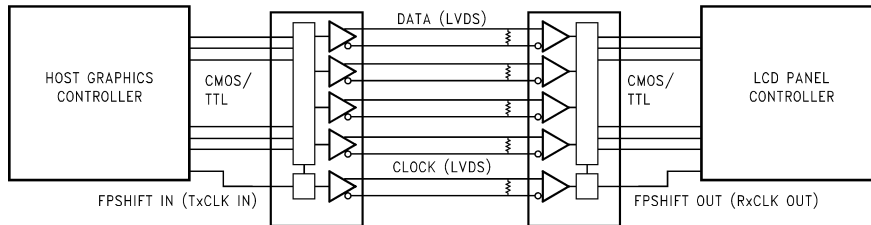

DS100033-3

Physical Dimensions inches (millimeters) unless otherwise noted

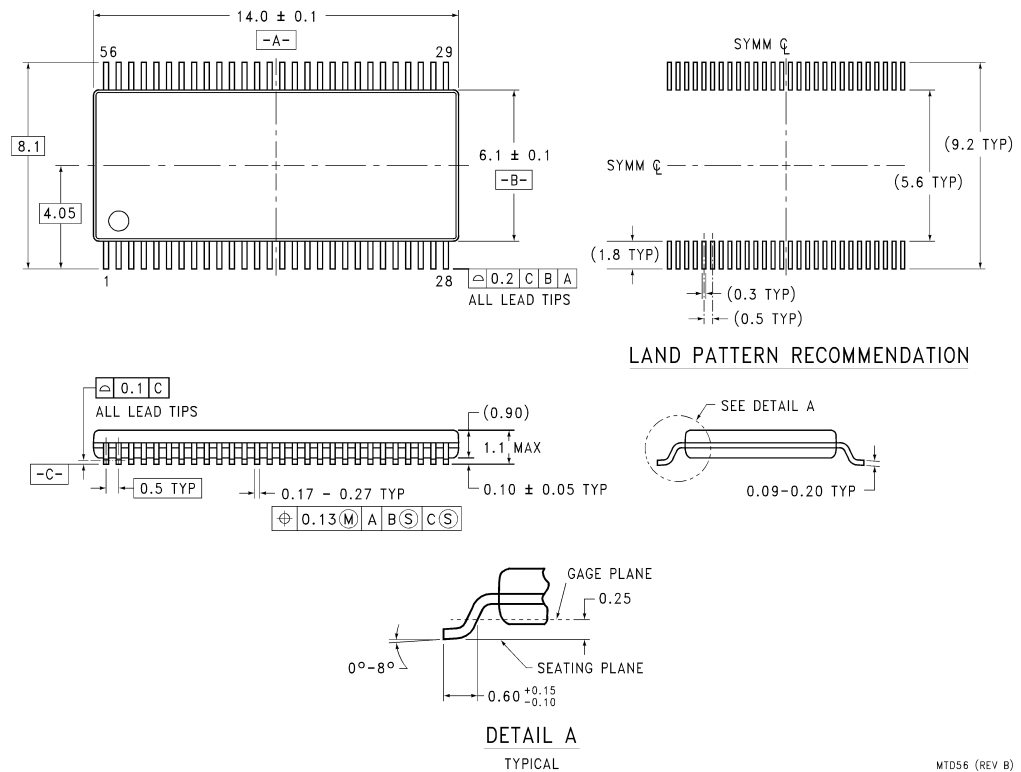

56-Lead Molded Thin Shrink Small Outline Package, JEDEC
Order Number DS90CF383MTD
NS Package Number MTD56

MTD56 (REV B)

LIFE SUPPORT POLICY

NATIONAL'S PRODUCTS ARE NOT AUTHORIZED FOR USE AS CRITICAL COMPONENTS IN LIFE SUPPORT DEVICES OR SYSTEMS WITHOUT THE EXPRESS WRITTEN APPROVAL OF THE PRESIDENT AND GENERAL COUNSEL OF NATIONAL SEMICONDUCTOR CORPORATION. As used herein:

1. Life support devices or systems are devices or systems which, (a) are intended for surgical implant into the body, or (b) support or sustain life, and whose failure to perform when properly used in accordance with instructions for use provided in the labeling, can be reasonably expected to result in a significant injury to the user.
2. A critical component is any component of a life support device or system whose failure to perform can be reasonably expected to cause the failure of the life support device or system, or to affect its safety or effectiveness.

 <p>National Semiconductor Corporation Americas Tel: 1-800-272-9959 Fax: 1-800-737-7018 Email: support@nsc.com www.national.com</p>	<p>National Semiconductor Europe Fax: +49 (0) 1 80-530 85 86 Email: europe.support@nsc.com Deutsch Tel: +49 (0) 1 80-530 85 85 English Tel: +49 (0) 1 80-532 78 32 Français Tel: +49 (0) 1 80-532 93 58 Italiano Tel: +49 (0) 1 80-534 16 80</p>	<p>National Semiconductor Asia Pacific Customer Response Group Tel: 65-2544466 Fax: 65-2504466 Email: sea.support@nsc.com</p>	<p>National Semiconductor Japan Ltd. Tel: 81-3-5639-7560 Fax: 81-3-5639-7507</p>
--	---	---	---

National does not assume any responsibility for use of any circuitry described, no circuit patent licenses are implied and National reserves the right at any time without notice to change said circuitry and specifications.